

Across Pool Volleyball / Badminton Game

72776

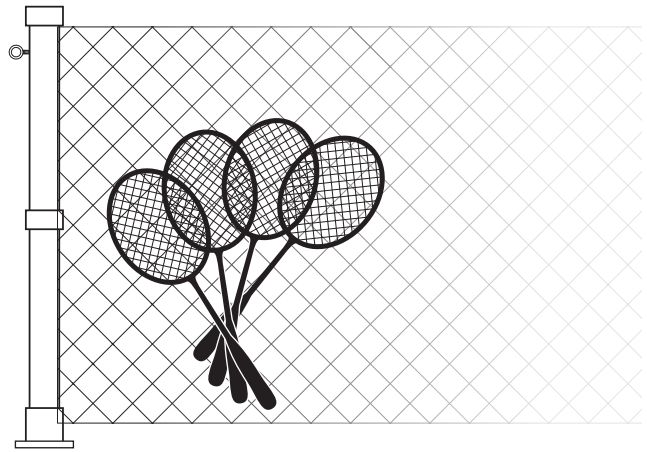
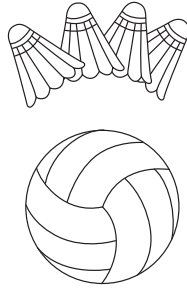

POOLMASTER®

770 Del Paso Road
Sacramento, CA 95834-0308

Contents

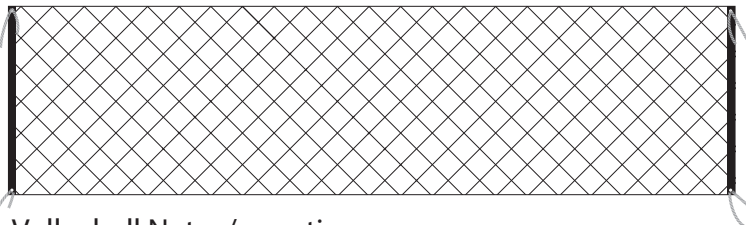

Volleyball Net w/rope ties
on each corner (extends up to 26')

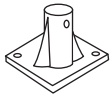

Rail Connector (2)



Cap for
Upright
Pole (2)

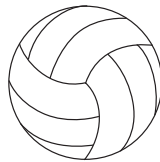

Volleyball

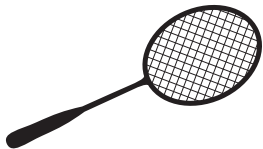

Badminton Racket (4)



Bird (4)



Ball Needle



Upright
Pole (4)



Set Screw #8 (4)



8ft Rope (4)



1" Bolt w/ Hex Nut (8)



Eyelet (2) w/ Washer (2)
and Hex Nut #10-24 (2)



1 3/4" Bolt (2) w/ 1/4-20 Hex Nut (2)



1" Coupling (2)

Product Care & Storage

Your new poolside game has been made with many non-corrosive quality materials and should provide you with many years of enjoyment with proper care. However, sun and chemically treated pool water (chlorine) are natural enemies of many synthetic materials. For maximum life of your game, please do the following:

1. Do not leave the game ball floating around the pool when not in use.
2. After use, wash away the chlorine pool water with plain water using a garden hose.
3. When not in use, store your game in a dry place away from direct sunlight.

Flathead Screwdriver

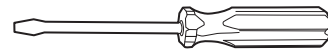

Recommended Tools

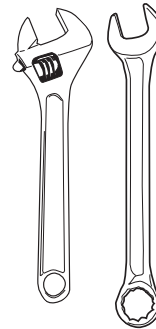

7/16" Open or Box Wrench
or Adjustable Wrench

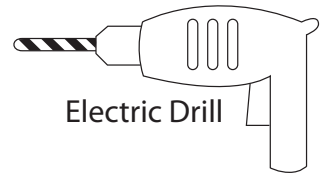

Electric Drill



3/16" Drill Bit

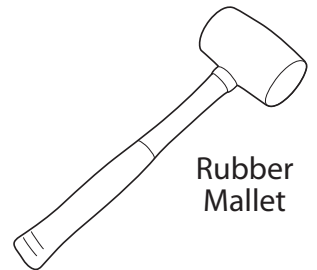

Rubber
Mallet

Questions or comments? Call:

800.854.1492

poolmaster.com
info@poolmaster.com

776-6

Assembly Instructions

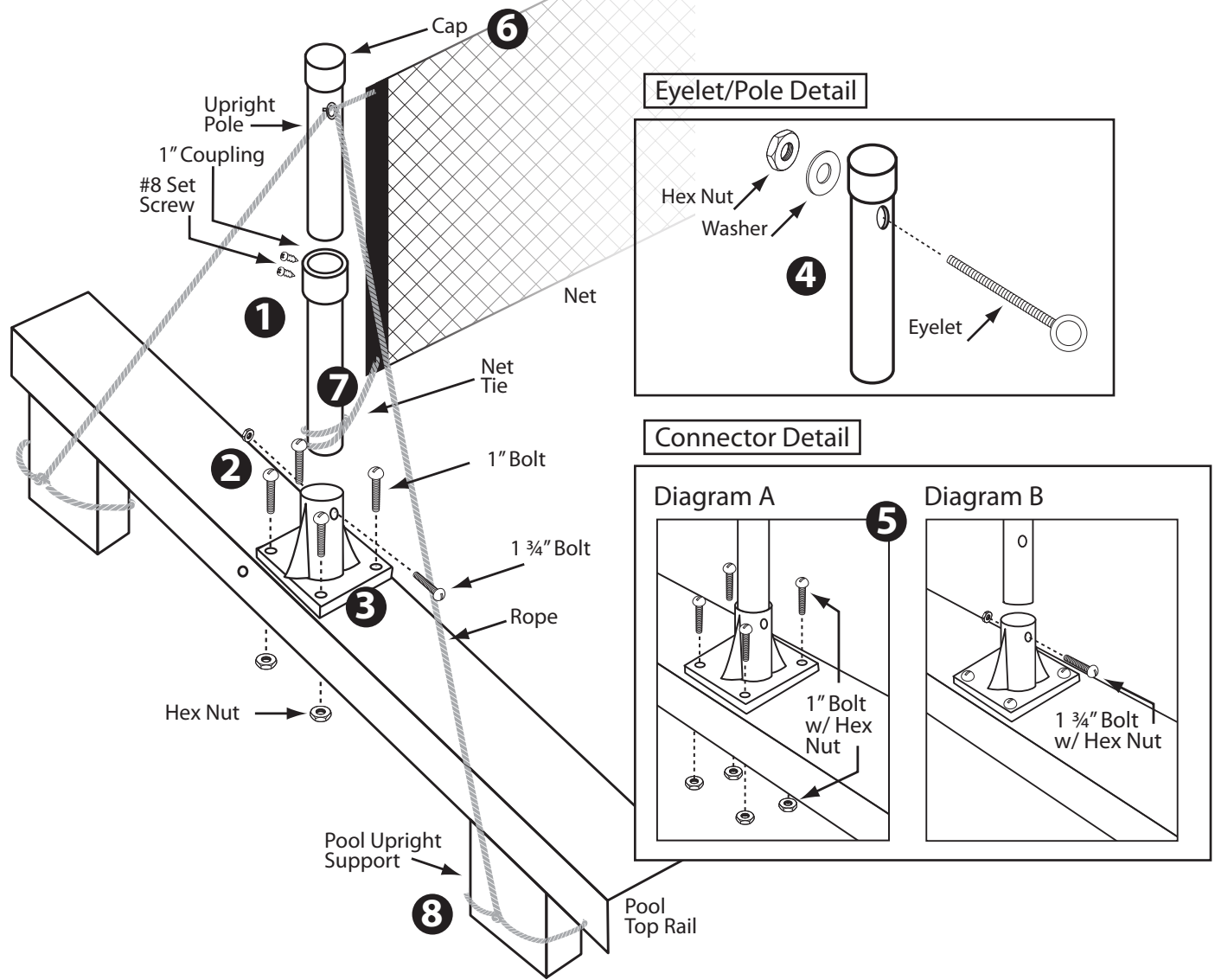

- 1 _____
• Secure Coupling between two upright poles and secure with 2 Set Screws. (Repeat for other set)
- 2 _____
• Situate the game on the pool top rail at your desired location. Using the holes in the Rail Connector as a guide, drill eight $\frac{3}{16}$ " holes in the top rail, four holes per connector.
- 3 _____
• Attach the connectors to the pool and secure with (8) 1" Nuts and Bolts. (Diagram A)
- 4 _____
• Insert Eyelet into the top holes on the Upright Pole Support (See Eyelet/Pole Detail) and fasten with Washer and Hex Nut. (Repeat for other side)
- 5 _____
• Insert the Upright Pole into the Rail Connector, secure with $1\frac{3}{4}$ " Bolts. (Repeat for other side) (Diagram B)
- 6 _____
• Extend the Net across the pool, pull tight and tie Net Ropes to the top of each pole through the Eyelets. Net can be shortened by rolling on pole or lengthened by extending the Rope Ties.
- 7 _____
• Tie net ropes to the bottom of each pole.
- 8 _____
• Tie two 8ft. Ropes to the Eyelet at the top of the Upright Pole and extend diagonally and tie to the Pool Upright Support. (Repeat for other side)

Jeu de Volleyball et de Badminton à Travers la Piscine

72776

POOLMASTER®

770 Del Paso Road
Sacramento, CA 95834-0308

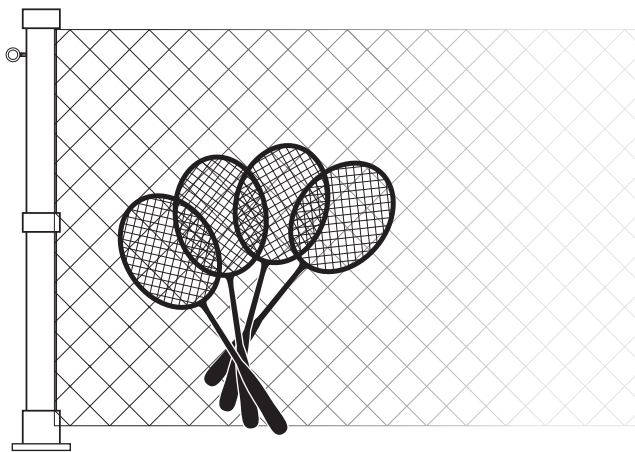
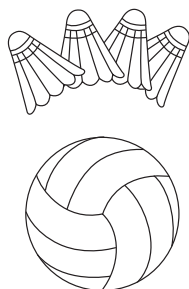

Contenu

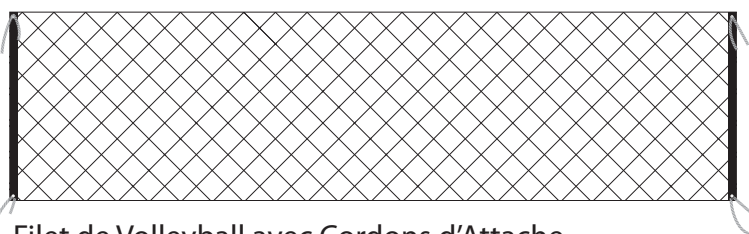

Filet de Volleyball avec Cordons d'Attache sur Chaque Coin s'Allonge Jusqu'à 7,92m

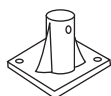

Connecteur de Rampe (2)



Embout pour Poteau Vertical (2)

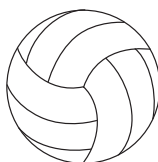

Volleyball

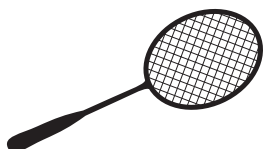

Raquette de Badminton (4)



Volant (4)



Aiguille pour Ballon



Poteau Vertical (4)



Vis de Serrage #8 (4)



Corde 2,44m (4)



2,54cm Boulon (8) avec Écrou Hexagonal (8)



Œillet (2) avec Rondelle (2) et Écrou Hexagonal #10-24 (2)



4,45cm Boulon (2) avec Écrou Hexagonal ¼-20 (2)



2,54cm Raccord (2)

Entretien du Produit et Entreposage:

Votre nouveau jeu pour bord de piscine a été fabriqué à l'aide de nombreux matériaux résistants à la corrosion de qualité et devrait vous offrir de nombreuses années de plaisir grâce à un entretien approprié. Cependant, le soleil et l'eau de piscine traitée avec des produits chimiques (le chlore) sont des ennemis naturels de nombreux matériaux synthétiques. Pour une durée de vie maximale de votre jeu, veuillez suivre les consignes suivantes:

1. Ne pas laisser le ballon flotter dans la piscine lorsqu'il n'est pas utilisé.
2. Après utilisation, laver pour éliminer l'eau chlorée de la piscine à l'aide d'un boyau d'arrosage.
3. Lorsqu'il n'est pas utilisé, veuillez ranger votre jeu dans un endroit sec à l'abri de la lumière directe du soleil.

Outils Recommandés

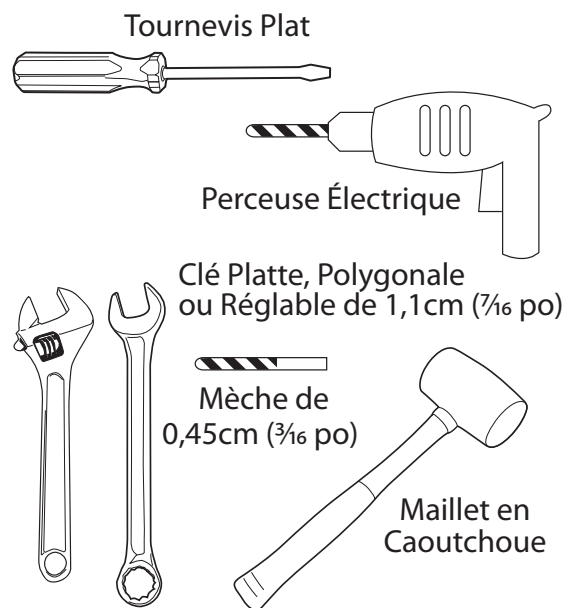

Tournevis Plat

Perceuse Électrique

Clé Platte, Polygone ou Réglable de 1,1cm (7/16 po)

Mèche de 0,45cm (3/16 po)

Maillet en Caoutchouc

Des questions ou des commentaires?

Composer le:

800.854.1492

poolmaster.com
info@poolmaster.com

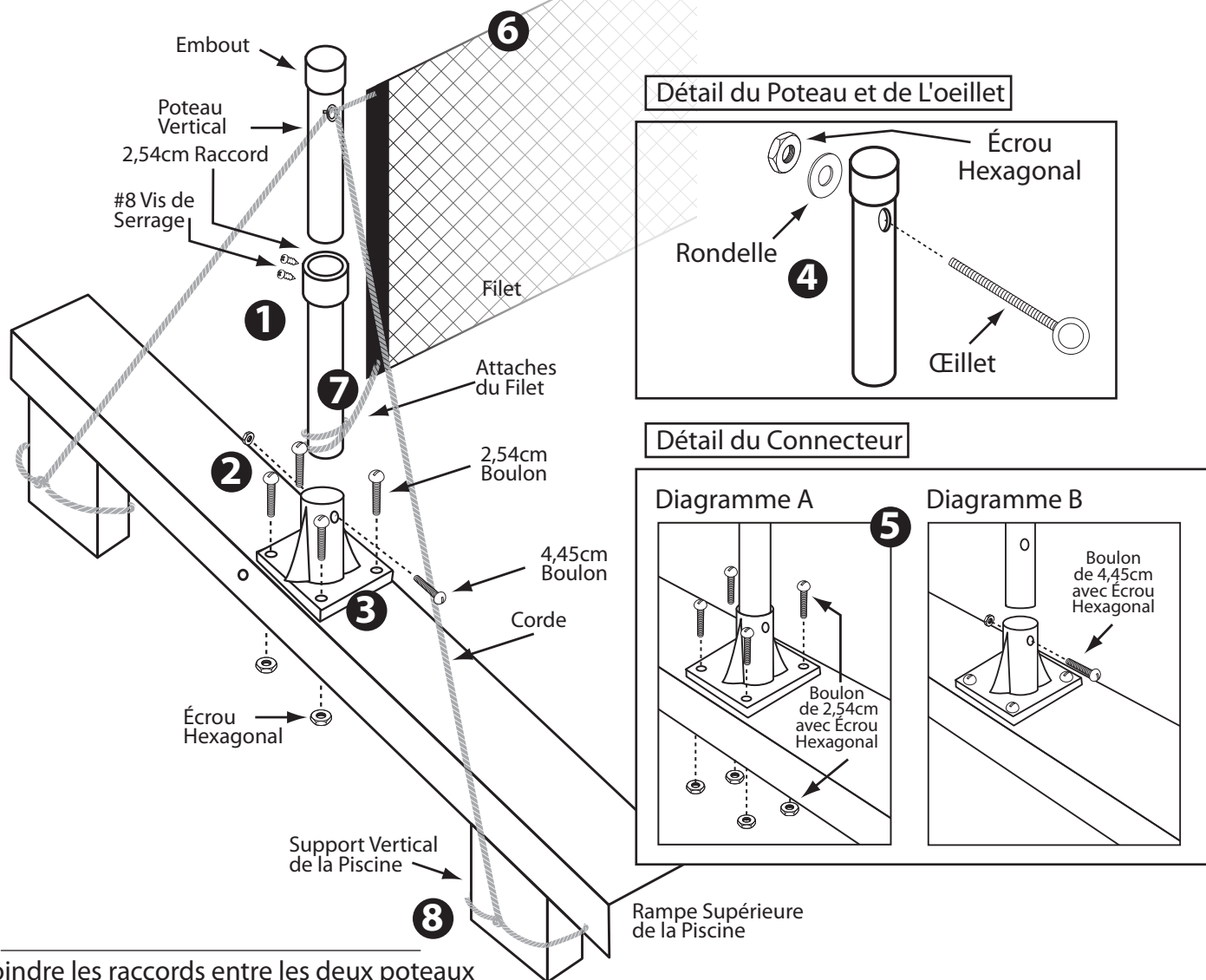

- 1 _____
- Joindre les raccords entre les deux poteaux verticaux et fixer à l'aide de 2 vis de serrage. (Répéter pour l'autre ensemble)
- 2 _____
- Placer le jeu sur le dessus de la rampe supérieure de la piscine à l'endroit souhaité. À l'aide des trous sur le connecteur de rampe pour vous guider, percer huit trous de 0,5cm sur la rampe supérieure, quatre trous par connecteur.
- 3 _____
- Attacher les connecteurs à la piscine et fixer à l'aide de (8) boulons et écrous hexagonaux de 2,54cm (Diagramme A).
- 4 _____
- Insérer l'oeillet dans le trou du haut du support du poteau vertical (voir le détail de l'oeillet et du poteau) et fixer à l'aide d'une rondelle et d'un écrou vertical. (Répéter l'opération de l'autre côté)
- 5 _____
- Insérer le poteau vertical dans le connecteur de rampe, fixer à l'aide de boulons de 4,45cm. (Diagramme B) (Répéter l'opération pour l'autre côté)
- 6 _____
- Étendre le filet à travers la piscine, tirer fermement et attacher les cordons supérieurs du filet dans le haut de chaque poteau à travers les œillets. Le filet peut être raccourci en l'enroulant sur le poteau ou rallongé en allongeant les cordons d'attache.
- 7 _____
- Attacher les cordons du filet au bas de chaque poteau.
- 8 _____
- Attacher deux cordes de 2,44m dans l'oeillet du haut du poteau vertical, étirer en diagonale et attacher au support vertical de la piscine. (Répéter l'opération pour l'autre côté)

Juego de Voleibol / Bádmin-ton a lo Ancho de la Piscina

72776

POOLMASTER®

770 Del Paso Road
Sacramento, CA 95834-0308

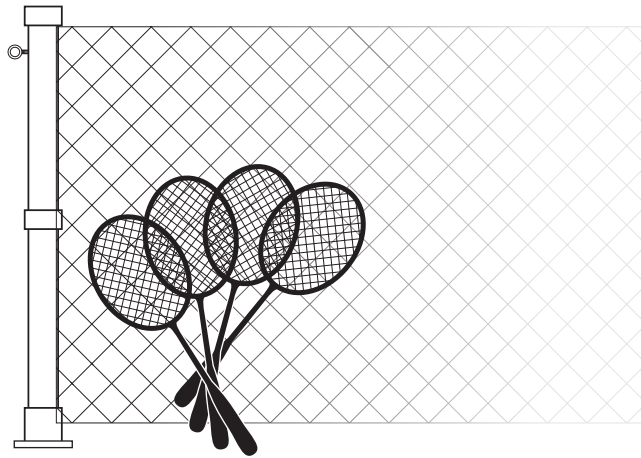
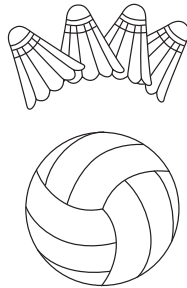

Contenidos



Red de Voleibol Con Ataduras de Cuerda en Cada Esquina se Extiende Hasta 7.92m

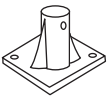

Conectore de Riel (2)



Tapa Para el Poste Vertical (2)

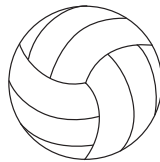

Voleibol

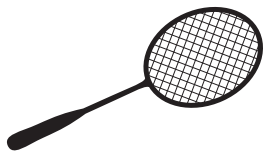

Raqueta de Bádmin-ton (4)



Volante (4)



Aguja para Balón



Tornillo Ajuste #8 (4)



Cuerda 2.44m (4)



Poste Vertical (4)



2.54cm Tornillo (8) con Tuerca Hexagonal (2)



Ojete (2) con Arandela (2) y Tuerca Hexagonal #10-24 (2)



4.45cm Tornillo (2) con Tuerca Hexagonal ¼-20 (2)



2.54cm Acople (2)

Cuidado y Almacenamiento del Producto:

Su nuevo juego para el área de la piscina/alberca fue fabricado con numerosos materiales de calidad anticorrosiva, y con el cuidado adecuado debería proporcionarle muchos años de disfrute. Sin embargo, el sol y el agua tratada químicamente de la piscina/alberca (cloro) son enemigos naturales de muchos materiales sintéticos. Para obtener la máxima vida útil de su juego, por favor haga lo siguiente:

1. No deje la pelota de juego flotando en la piscina/alberca cuando no esté en uso.
2. Luego de usar, enjuague el agua clorada de la piscina/alberca con agua dulce utilizando una manguera de jardín.
3. Cuando no se encuentre en uso, guarde su juego en un lugar seco, lejos de la luz solar directa.

Herramientas Recomendadas



Taladro Eléctrico

Destornillador de Paleta

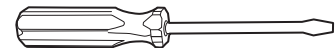

Llave Poligonal o de Apertura de 1.1cm (7/16 Pulgadas) o Llave Ajustable

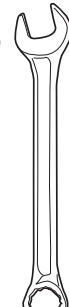

Broca de 0.45cm (3/16 Pulgadas)



Mazo de Goma

¿Preguntas o comentarios? Llame al:

800.854.1492

poolmaster.com
info@poolmaster.com

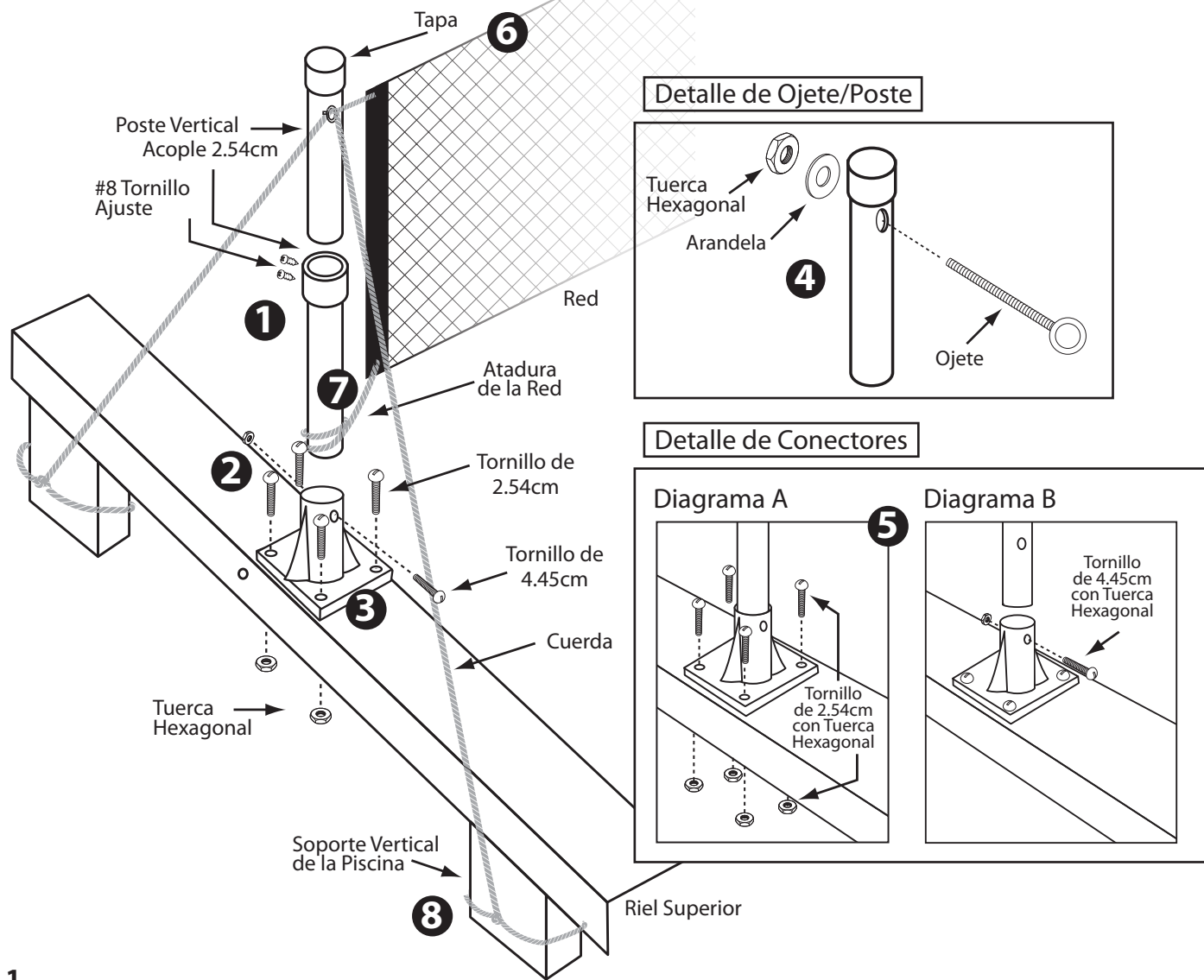

- 1 _____
- Asegure el acoplamiento entre dos postes verticales y asegúrelos con 2 tornillos ajuste. (Repítalo para el otro juego)
- 2 _____
- Coloque el juego en el riel superior de la piscina en el lugar deseado. Usando los orificios en el conector de riel como guía, perforo orificios de 0.5cm en el riel superior, cuatro orificios por conector.
- 3 _____
- Una los conectores a la piscina y asegúrelos con (8) tornillos y tuercas de 2.54cm. (Diagrama A)
- 4 _____
- Introduzca los ojete en los orificios superiores en el soporte del poste vertical (Ver Detalle de Ojete/Poste) y ajuste la arandela y la tuerca hexagonal. (Repetir para el otro lado)
- 5 _____
- Introduzca el poste vertical en el conector de riel, asegúrelo con tornillos de 4.45cm (Diagrama B) (Repítalo para el otro lado)
- 6 _____
- Extienda la red a lo largo de la piscina, tire fuerte y ate las cuerdas de la red a la parte superior de cada poste a través de los ojete. La red puede acortarse enrollándola en el poste o se puede alargar extendiendo las ataduras en la cuerda.
- 7 _____
- Ate las cuerdas de la red abajo de cada poste.
- 8 _____
- Ate dos cuerdas de 2.44m al ojete en la parte superior del poste vertical y extiéndalas en diagonal y ate el soporte vertical de la piscina. (Repítalo para el otro lado)